

**snom 300**  
VoIP Business Phone



**Quick Installation  
Kurzanleitung**

**snom technology AG**  
**Charlottenstraße 68-71**  
**10117 Berlin, Germany**

## **Note to the reader**

---

This is a quick guide to the installation and operation of the snom 300. The full manual is available on our web page, [www.snom.com/wiki](http://www.snom.com/wiki).

### **© 2008 snom technology Aktiengesellschaft.**

All Rights Reserved. This document is supplied by snom technology AG. No part of this document may be reproduced, republished or retransmitted in any form or by any means whatsoever, whether electronically or mechanically, including, but not limited to, by way of photocopying, recording, information recording or through retrieval systems, without the express written permission of snom technology AG.

snom technology AG reserves the right to revise this document and make changes at any time and without the obligation to notify any person and/or entity of such revisions and/or changes.

Product specifications contained in this document are subject to change without notice.

---

# Table of Content

---

Note to the reader .....	2
<b>Installation .....</b>	<b>5</b>
Delivery Content .....	5
Safety Information.....	5
Power supply.....	5
Setting up the Phone.....	6
Wall Mounting .....	7
Cleaning .....	9
<b>Connecting the phone .....</b>	<b>11</b>
<b>Keypad .....</b>	<b>13</b>
<b>Initialization.....</b>	<b>17</b>
Booting .....	17
Selecting the language .....	17
DHCP Configuration.....	17
Setting the IP Address.....	18
Setting the Netmask .....	18
Setting the IP Gateway.....	18
Setting the DNS Server .....	19
Selecting the Tone Scheme .....	19
Selecting the Timezone.....	19
Logging on the first account.....	20
<b>Index .....</b>	<b>23</b>



# Installation



## Delivery Content

Please check whether the delivery contains the following parts:

- Base unit with display and keypad
- Handset
- Handset cable
- Power supply
- Paper template



## Safety Information

Please read the following safety notices before installing or using your snom phone. They are crucial for the safe and reliable operation of the device.

## Power supply

You have two options for providing the snom 300 with power:

- An external power supply (5 V)
- Power feeding over the network cable (IEEE 802.3af compatible)

If you want to use an external power supply, use the one that is included in the package. Other power supplies may cause damage to the phone, affect its behavior or induce noise.

## Setting up the Phone

### 1

Your snom 300 is delivered with the footstand (shaded light gray in Fig. 1) attached to the phone's bottom shell in the position for desktop placement. Place the snom 300 on an even, horizontal surface that gives the rubber pads a secure grip. Do not place it on carpets or other materials containing fibers that could block the air vents and cause overheating.

Connect one end of the handset cable to the handset and the other end to the jack labeled "📞" on the phone's bottom shell. Clip the handset cord into the groove on the bottom shell of the phone, as shown in Fig. 1.

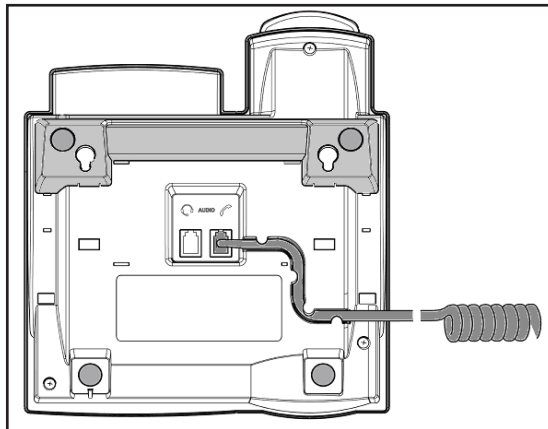

Fig. 1

## Wall Mounting

It is also possible to mount the snom 300 on the wall. In order to do this, detach the footstand from the bottom shell and attach it in the appropriate position for wall mounting, as described in steps 1 through 4, below.

Make sure that the handset cord has been clipped correctly into the groove on the bottom shell of the phone, as shown in Fig. 1. Failure to clip the cord into the groove may result in damage to the cord when the footstand is attached in the position for wall mounting.

- 1** Turn the phone upside down (Fig. 2). Please, ensure that you do not damage the display and that you do not drop the receiver. You may want to hold the phone in your lap or have a second person hold it.

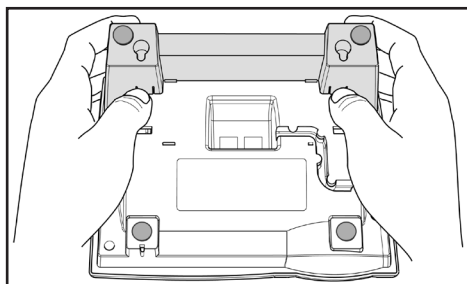

Fig. 2

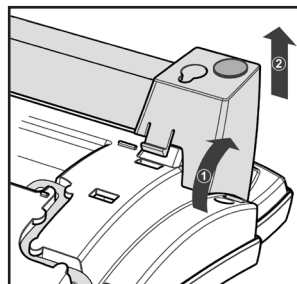

Fig. 3

- 2** Lightly press the snap-fits of the footstand inwards and, at the same time, tilt the footstand backwards and lift it from its anchorage in the mounting holes (Fig. 3).

[ SNOM 300 QUICK INSTALLATION V1.02 ]

- 3 Rotate the footstand 180° around its vertical axis.
- 4 Insert the outside, rear snap-fits into the mounting holes on the bottom shell (Fig. 4, arrow no. 1). Tilt the footstand forward and downward until the snap-fits snap into place in the mounting holes (arrow no. 2). **Please, make sure that the four snap-fits have securely snapped into the holes before mounting the phone on the wall.**

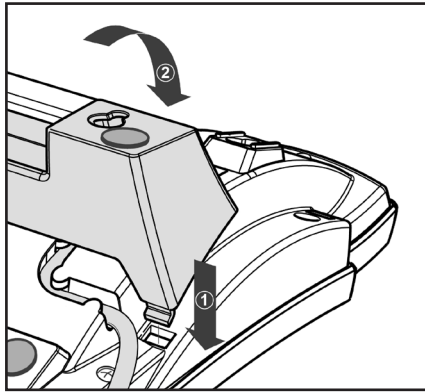

Fig. 4

The delivery includes a template to be used for marking the position of the holes to be drilled in the wall.

Use wall plugs, if necessary, and screws with half-round head profiles (diameters of screws  $d_{max} = 4.5 \text{ mm}$  (0.177"), diameters of heads  $d_{max} = 8 \text{ mm}$  (0.315")).

The screws must protrude approx. 0.5 cm (0.197") from the wall for easy wall mounting of the phone.



## Adjusting the Handset Rest for Wall Mounting

The speaker of the handset has a small, rectangular indentation that fits over the rounded end of the plastic tab inserted into a slot on the top shell of the phone. When the phone is mounted on the wall, the handset must be placed on this rounded end to ensure that it will not fall off.

Slide the tab out of the slot, as shown in Fig. 5, rotate it 180°, and slide it back into the slot, as shown in Fig. 6.

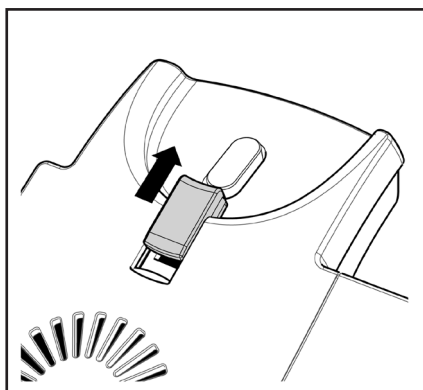

Fig. 5

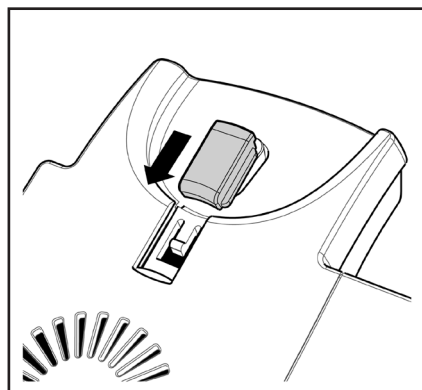

Fig. 6

## Cleaning

To clean the snom 300, use an anti-static cloth. Please avoid cleaning liquids as they might damage the surface or the internal electronics of the phone.



English



[ SNOM 300 QUICK INSTALLATION V1.02 ]



# Connecting the phone



Plug the Ethernet (network) cable into the RJ45 connector labeled "NET" and plug the other end into the network side to establish a data link. The second RJ45 connector, labeled "PC", is for daisy-chaining further Ethernet devices without the need for a second Ethernet connection line.

Insert the plug of the power supply into the connector labeled "DC 5V" and hook up the casing into the mains.

If you want to use a headset, connect it to the RJ audio jack labeled "📞" on the bottom shell of the phone.

Fig. 7 shows the connected phone with the footstand attached in the position for desktop placement. Fig. 8 shows the connected phone with the footstand attached in the position for wall mounting.

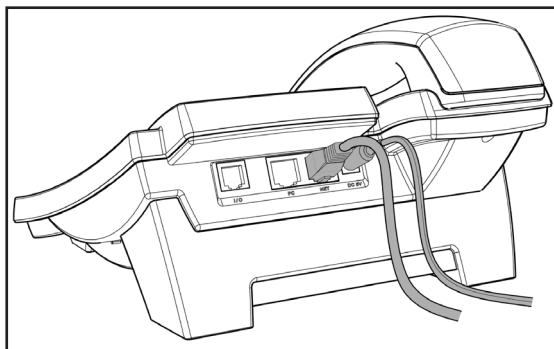

Fig. 7

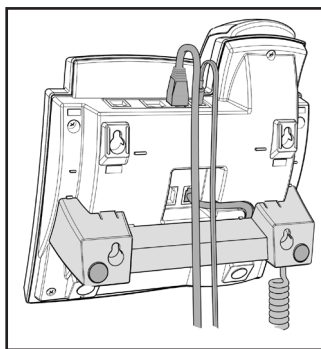
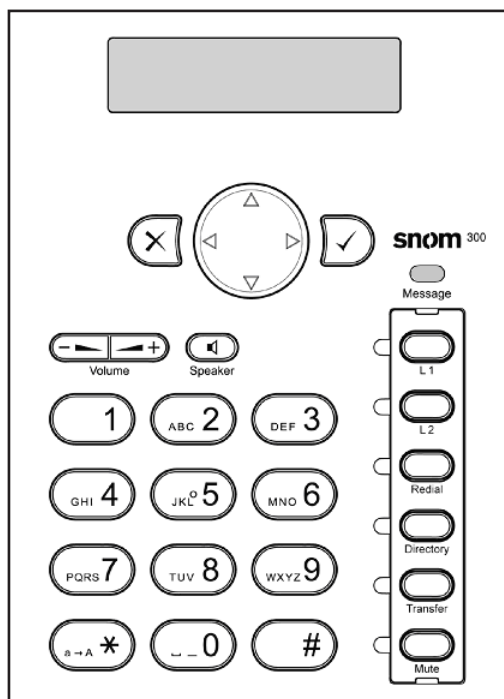

Fig. 8



# Keypad



Navigation key - for navigation within the display menu and the phone book



ENTER key - to confirm actions, selections and inputs



CANCEL key - to cancel actions or input



LED for MWI (message waiting indication)

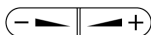

Adjusts the volume (lower/higher)



Turns the casing speaker on/off











The numeric keypad with the keys 0 to 9, \*, and # is used to enter digits and letters. Depending on the operating mode, different actions can be performed (see the table below):

- Entry of digits only (e.g., when dialing a phone number)
- Typing in letters and digits by pressing the keys repeatedly (similar to a cellular phone), etc.



## 3

Depending on the operating mode, the keys can have context-specific meanings which are described in the manual.







The keys of the numeric block in different operating modes:

Key	Digits	Lower case	Upper case
	0	(SPC)_0	(SPC)_0
	1	. @ 1 , ? ! - /( : ; & % * # + < = > \$ [ ]	. @ 1 , ? ! - /( : ; & % * # + < = > \$ [ ]
	2	abc2	ABC2
	3	def3	DEF3
	4	ghi4	GHI4
	5	jkl5	JKL5
	6	mno6	MNO6
	7	pqrs7\$	PQRS7\$
	8	tuv8	TUV8
	9	wxyz9	WXYZ9
	"#" or "." after time-out	Number guessing	

	<p style="text-align: center;">*</p>	<p>Toggles upper and lower case, when pressed briefly. Locks the keyboard when pressed for a few seconds, as indicated by a small lock symbol in the lower right corner of the display; pressing the key again for a few seconds will unlock the keyboard.</p>
---	--------------------------------------	--

The six keys with LEDs   on the right side of the keypad are programmable function keys onto which different functionalities can be mapped.

The default mappings are:

Key	Description
	<p>Trunk lines 1 &amp; 2.</p>
	<p>An incoming call is indicated by the fast-blinking LED of the trunk line. To pick it up, press the corresponding key.</p> <p>To put the call on hold, press the key again. To pick up a call on hold, as indicated by the slow-blinking LED, press the corresponding key.</p>
	<p>Redial</p>
	<p>Opens the phone book. Use the navigation key to scroll within the phone book.</p>
	<p>Call transfer.</p> <p>Announced transfer: Put the call on hold as described above and dial the number it is to be transferred to. When the phone is answered, press the TRANSFER key.</p> <p>Blind transfer: With the caller on the line, press the TRANSFER key, then dial the phone number the call is to be transferred to and press .</p>
	<p>Mute microphone (on/off)</p>



English

[ SNOM 300 QUICK INSTALLATION V1.02 ]

3







# Initialization



## Booting

The booting process comprises a series of different configuration steps that set up the phone for future use by any user.

## Selecting the language

The default language setting is English. After startup the phone offers you the option to select the language of your choice. To change to a different language, use the  or  keys and press  to confirm.

```
Select Language:
English
```

## DHCP Configuration

If your network supports DHCP, press  when this screen appears:

```
Are you using
DHCP?
```

The phone has a built-in DHCP client. It will receive an IP address and other network-related settings (Netmask, IP gateway, DNS server) from the DHCP server.

If your network does not support DHCP, press  when the above screen appears. The user will subsequently be asked for the following settings:

## Setting the IP Address

The user can provide a static IP address for the phone if DHCP is not used. A valid IP address appropriate to the network in which the phone is being used can be provided.

```
IP Address:
■92.168.0 .130
```

### 4

The following edit functions are available for the editing of the IP address and the following configurations:



Clear present setting



Move cursor to the right



Backspace and delete sign to the left of the cursor



Move cursor to the left



Confirm input

## Setting the Netmask

Similarly, the user will be asked to provide a netmask. After entering the information, confirm with .

```
Netmask:
■55.255.0 .0
```

## Setting the IP Gateway

If a valid netmask has been provided, the user will be asked for the IP address of the IP gateway. After entering the information, confirm with .

```
IP Gateway:
■92.168.0 .1
```

## Setting the DNS Server

---

The last item for this series of network-related configurations is the IP address for the DNS server. After entering the information, confirm with .

```
DNS Server:
■92.168.0 .9
```

4

## Selecting the Tone Scheme

---

The user will then be asked for the tone scheme to be used on the phone. After moving the cursor with the navigation key to the tone scheme you wish to use, confirm with .

```
Select Dialtone:
  Australia
```

## Selecting the Timezone

---

The timezone to be used on the phone can also be selected by moving through the different timezone options available in the menu and pressing  to confirm your selection.

```
Select Timezone:
-10: USA (Honolu
```

If the settings explained above are set up properly, the phone will ask for the first account registration.

## Logging on the first account

---

If no number is assigned to the phone yet, you will be prompted to type in your account name.

Navigation key mapping:



Move cursor to the left



Change edit mode (123 for numerals, abc for small letters, ABC for capital letters)



Move cursor to the right



Backspace and delete sign to the left of the cursor



Confirm entry

**4**

```
Account:      abc
█
```

The phone will then try to guess the correct registrar. If the registrar shown on the display is incorrect, please correct the information. The screen might show something like this:

```
Registrar:    abc
intern.snom.de█
```

Confirm by pressing . You will then be asked whether you want to use ENUM.

```
Use ENUM?
```

Press  if you wish to use ENUM or , if you do not. If you have chosen ENUM, you will be asked for the country code (e.g., 1 for the US) and the area code (e.g., 802 for Vermont). ENUM means that a conventional E.164 number (normal phone numbers) is mapped to a SIP URI so that a pure IP call can be started instead of an IP/PSTN call. Regarding ENUM see also our white paper „ENUM on snom phones“.

Country Code:  
■

Area Code:  
■

4

Enter the codes and confirm with  each time.

The phone tries to register your given account name at the given registrar. The idle screen appears. Your registration has been successful if the identity you have just configured is shown in the top line. If, however, the letters „NR“ are shown instead, the registration has not been successful.

490 11:31PM  
■

When the time server has been successfully contacted, the time is also shown on the display.

**The complete manual is available on our web page,  
[www.snom.com/wiki](http://www.snom.com/wiki).**





---

# Index

---

## A

---

Account 20

## B

---

Booting 17

## C

---

Call transfer 15

Cleaning 9

Connecting the phone 11

## D

---

DHCP 17

DNS Server 19

## E

---

ENTER key 13

## F

---

Forwarding. *see* Transfer

## H

---

Handset rest 9

## I

---

Installation 5

IP Address 18

IP Gateway 18

## K

---

Keypad 13

## L

---

Language 17

LEDs 15

LED for MWI 13

## M

---

Manual 21

Mute microphone 15

## N

---

Netmask 18

Numeric block 14

Numeric keypad 14

## O

---

Open phone book 15

## P

---

Power supply 5

## R

---

Redial 15

## S

---

Safety Information 5

Setting up the Phone 6

## T

---

Timezone 19

Tone scheme 19

Transfer..15

## W

---

Wall mounting 6